

Article number: 20126460RT

Description: E+G Ball knob DIN 319-KU-40-M10-C-RT

Measures

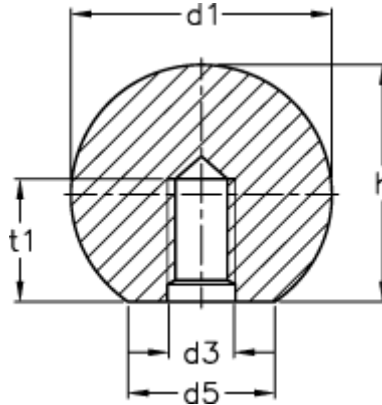

d1	= 40
d3	= M10
d5	= 22
h	= 37.0
t1 min.	= 18.0